

Varenummer: 58MI20S0350CAG
 Beskrivelse: Cylinder MI-20x350-S-CA-G, Ø20x350
 gummidæmpning - port 1/8"

Mål

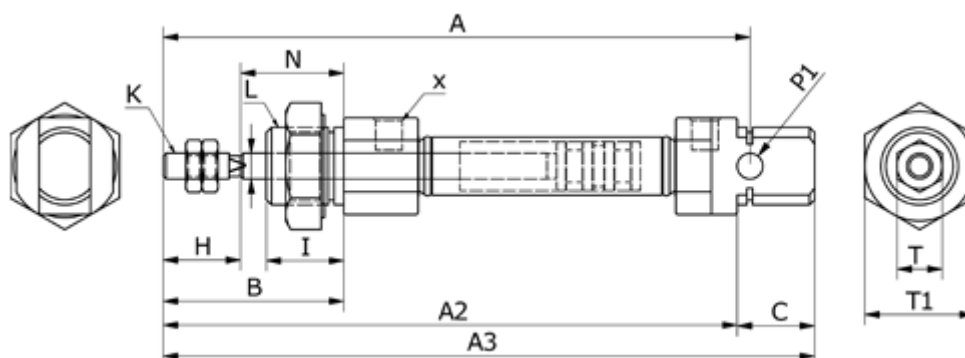

A	= 115	K	= M8x1,25	V = 8
A2	= 62	L	= M22x1,5	X = 1/8"
A3	= 126	N	= 24	
B	= 44	O	= 11	
Boringsdiameter	= 20	P1	= 8	
C	= 20	Slaglængde	= 350	
HS	= 20	T	= 12	
I	= 20	T1	= 29	